

Alpha **HPA**

The Manager Companies - ASX Limited
20 Bridge Street
Sydney NSW 2000

ASX: **A4N**
ASX Announcement
9 November 2021
(28 pages)

PRESENTATION TO INVESTORS AND WEBCAST DETAILS

Attached is a presentation, which is being presented by Alpha HPA Limited's Managing Director, Mr Rimas Kairaitis, to investors at 11.00am today.

Investors can register to watch a webcast of the presentation, which will also be followed by a Q&A session, the details for which are as follows:

- **Time:** 11.00am ADST
- **Date:** 9 November 2021
- **Webcast link** (watch only): - <https://webcast.openbriefing.com/8106/>
- **Teleconference Registration link** (for Q&A participation):
- <https://s1.c-conf.com/diamondpass/10017940-asmw72.html>

For further information, please contact:

Rimas Kairaitis
Managing Director
rkairaitis@alphaHPA.com.au
+61 (0) 408 414 474

Cameron Peacock
Investor Relations & Business Development
cpeacock@alphaHPA.com.au
+61 (0) 439 908 732

pjn11018



ULTRA PURE ALUMINIUM PRODUCTS FOR DE-CARBONISATION



Alpha HPA

Cautionary Statement

The Definitive Feasibility Study (DFS) referred to in this presentation has been undertaken to assess the technical and financial viability of the HPA First project. The DFS is based on the material assumptions about the availability of funding and the pricing received for HPA. While the Company considers all of the material assumptions to be based on reasonable grounds, there is no certainty that they will prove to be correct or that the outcomes indicated by this DFS will be achieved. To achieve the range of outcomes indicated in the DFS, additional funding will be required. Investors should note that there is no certainty that the Company will be able to raise the amount of funding when needed. It is also possible that such funding may only be available on terms that may be dilutive to or otherwise affect the value of the Company's existing shares. It is also possible that the Company could pursue other 'value realisation' strategies such as a sale, partial sale or joint venture of the HPA First project. If it does, this could materially reduce the Company's proportionate ownership of the HPA First project. Given the uncertainties involved, investors should not make any investment decisions based solely on the results of the DFS.

Forward Looking Statements

This presentation contains certain forward-looking statements with respect to the financial condition, results of operations, and business of the Company and certain plans and objectives of the management of the Company. These forward-looking statements involve known and unknown risks, uncertainties and other factors which are subject to change without notice and may involve significant elements of subjective judgement and assumptions as to future events which may or may not occur. Forward-looking statements are provided as a general guide only and there can be no assurance that actual outcomes will not differ materially from these statements. Neither the Company, nor any other person, give any representation, warranty, assurance or guarantee that the occurrence of the events expressed or implied in any forward-looking statement will actually occur. In particular, those forward-looking statements are subject to significant uncertainties and contingencies, many of which are outside the control of the Company. A number of important factors could cause actual results or performance to differ materially from the forward looking statements. Investors should consider the forward looking statements contained in this DFS in light of those disclosures.

This presentation is for information purposes only. Neither this presentation nor the information contained in it constitutes an offer, invitation, solicitation or recommendation in relation to the purchase or sales of shares in any jurisdiction. The presentation may not be distributed in any jurisdiction except in accordance with the legal requirements applicable in such jurisdiction. Recipients should inform themselves of the restrictions that apply to their own jurisdiction as a failure to do so may result in a violation of securities laws in such jurisdiction. This presentation does not constitute investment advice and has been prepared without considering the recipients investment objectives, financial circumstances or particular needs and the opinions and recommendations in this presentation are not intended to represent recommendations of particular investments to particular persons. Recipients should seek professional advice when deciding if an investment is appropriate. All securities' transactions involve risks, which include (among others) the risk of adverse or unanticipated market, financial or political developments. To the fullest extent of the law, Alpha HPA Limited, its officers, employees, agents and advisors do not make any representation or warranty, express or implied, as to the currency, accuracy, reliability or completeness of any information, statements, opinion, estimates, forecasts or other representations contained in this presentation. No responsibility for any errors or omissions from the announcement arising out of negligence or otherwise is accepted.

WE SUPPLY E-MOBILITY

The next major driver of de-carbonisation



Gasoline Only



Average Emissions

380

Grams of CO₂e per mile

Plug-in Hybrid Electric



209

Grams of CO₂e per mile

Battery Electric



154

Grams of CO₂e per mile

Source: Inside EV's (www.insideevs.com)

CO₂ Emissions

50%



WE SUPPLY

- ✓ HPA for separators
- ✓ Al-precursors for cathode
- ✓ Al-precursors for anode



Alpha HPA

WE SUPPLY LED-LIGHTING

The current technology driver of de-carbonisation

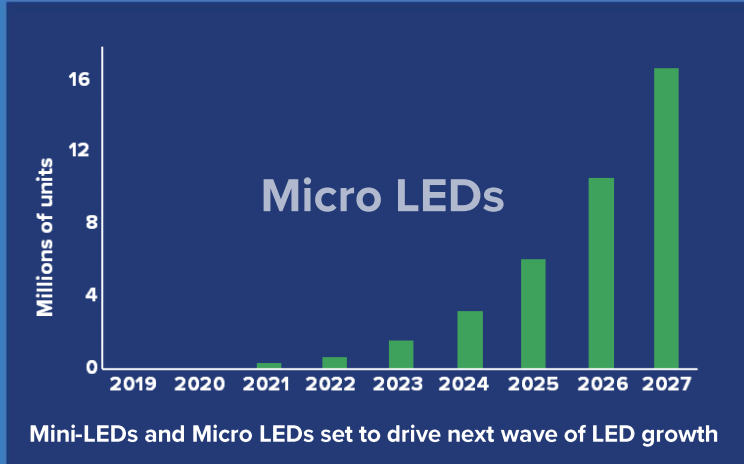

LEDs reduced CO₂e by an est. 570m tons in 2017

Reducing new power stations by 1,250

IN 2017, THE USE OF LEDS TO ILLUMINATE BUILDINGS AND OUTDOOR SPACES REDUCED CO₂ EMISSIONS BY NEARLY

570 MILLION TONNES

75%

PROJECTED ENERGY SAVINGS IN US LIGHT ENERGY CONSUMPTION BY 2035

LED lights are 50-70% more efficient than incandescent

A COMPLETE SWITCH TO LED LIGHTING WORLD WIDE, WOULD PREVENT 1,400,000,000 TONNES OF CO₂ EMISSIONS

ANNUAL CO₂ EMISSIONS SAVINGS FROM GLOBAL LED ADOPTION BY 2035

EQUIVALENT TO 200 MILLION CARS

OR 200 NEW COAL FIRED POWER STATIONS

WE SUPPLY

- HPA for LED sapphire substrates
- HPA for LED phosphors
- Al-precursors for LED phosphors

Alpha HPA

Sources: US Dept of Energy, www.microled-info.com & IHS Markits

Alpha HPA: Introduction

- We are a technology/industrial chemical company
- We offer exposure to the rapidly growing Li-ion battery and LED lighting markets
- We do this through a suite of ultra-high purity aluminium products which are:
 - **Critical raw materials for de-carbonisation**
- Our proprietary process delivers us the competitive edge
 - **High purity/low CapEx/low OpEx**
- Low carbon, sustainable process.
- We are commercialising our technology as the
HPA FIRST PROJECT
- The HPA First Project to deliver annual free cash flows of between **AUD\$133 - \$280M pa**



RioTinto



HPA First Project Site
Gladstone State Development Area,
North Queensland

- 10ha project site secured
- Adjacent to Orica Australia to allow for Project Interface
- Definitive Orica Agreements executed – August 2021

HPA First Project: Location



Process Flow Sheet: Disruptive and Flexible

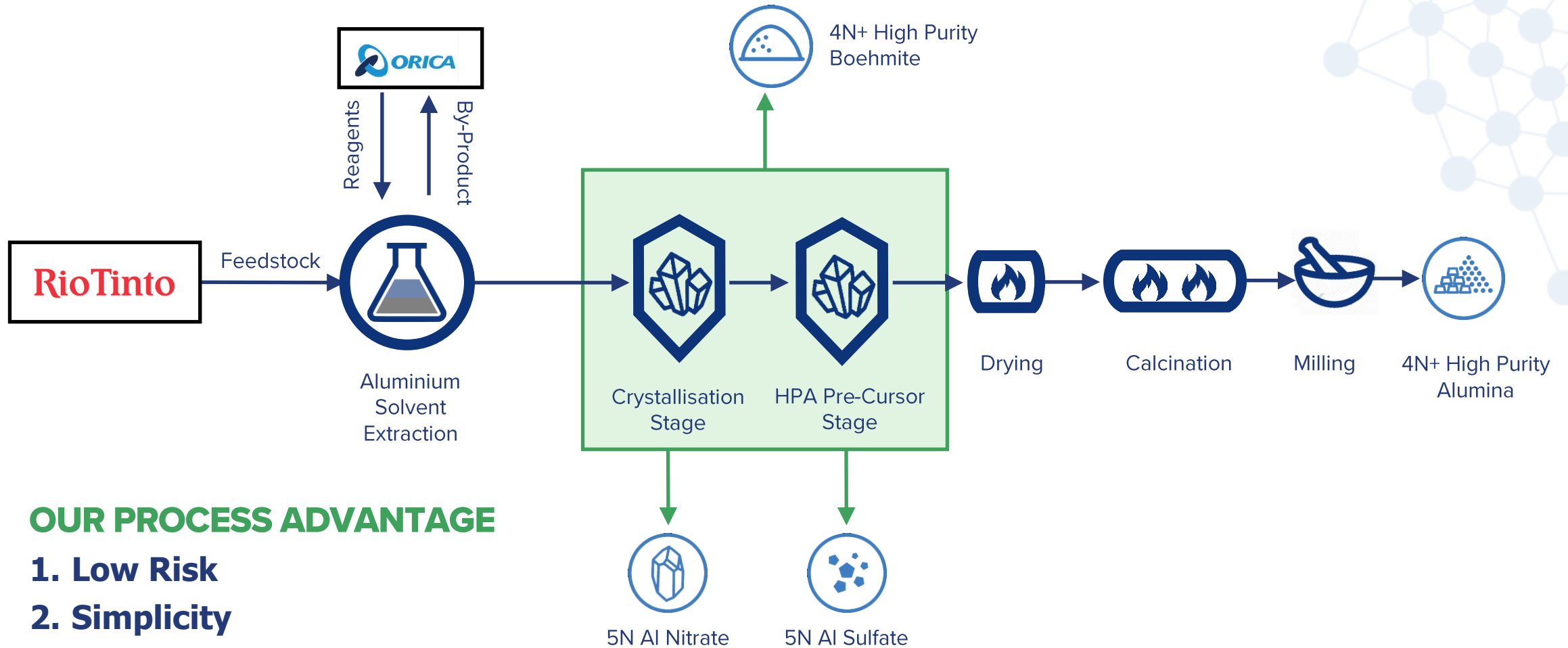

OUR PROCESS ADVANTAGE

1. Low Risk
2. Simplicity
3. Purity
4. Flexibility

Alpha HPA & Orica: Project Synergy

- Project partnership with ASX 100 Company Orica (ASX:ORI)
- Binding agreements in place
- Project integration with 100% recycle of process reagents as by-product.

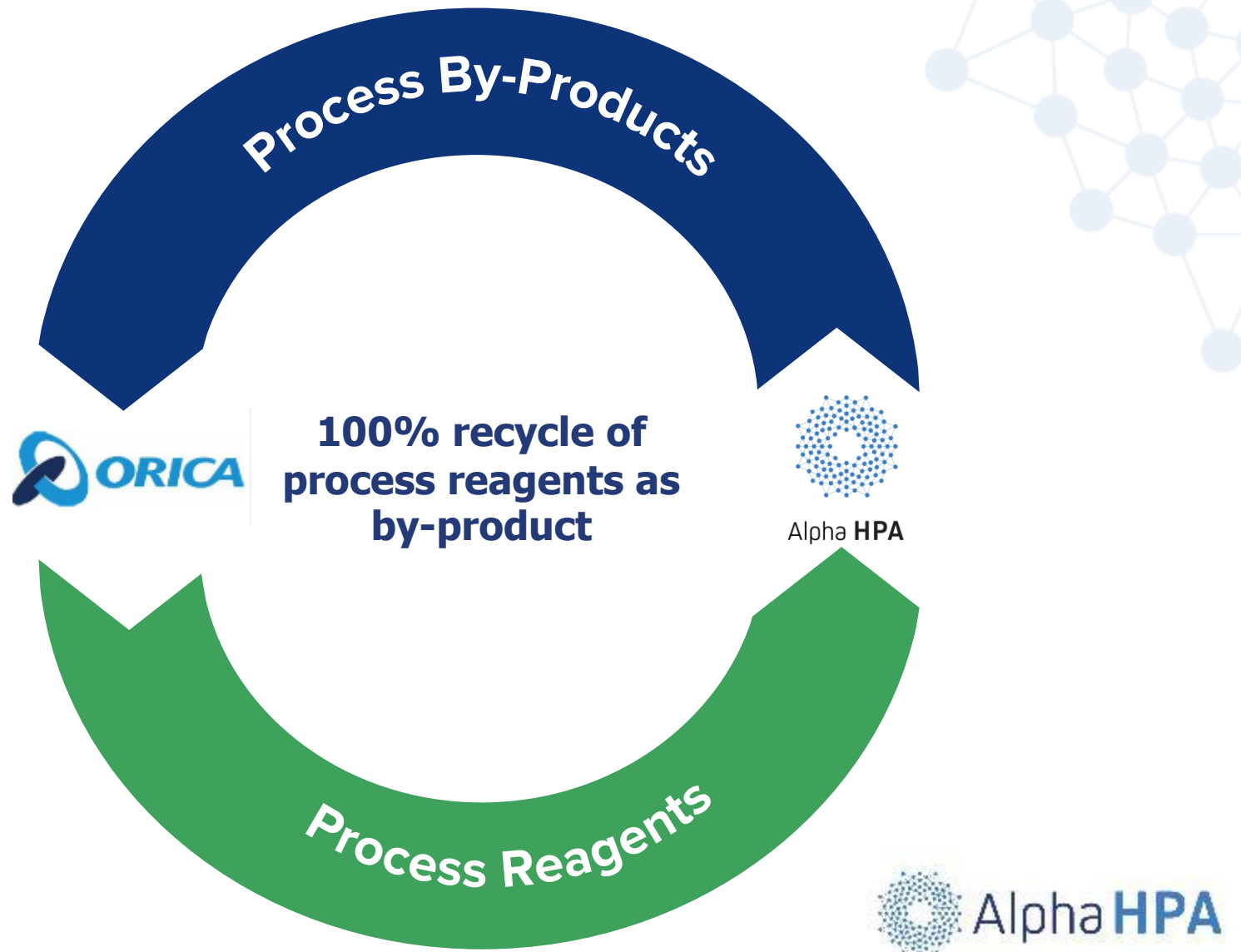

Our products:

High Purity Aluminas



Ultra High Purity Alumina Powder & Tablets

>99.995% (4N5) purity HPA engineered to suit customers specifications such as bespoke particle sized powders, sintered and un-sintered granules and sintered custom ingots.



Ultra Boehmite

A bespoke engineered >99.995% (4N5) purity Boehmite to suit specific customer requirements, ideal for LiB separator coatings and as a precursor for speciality applications.



Ultra Aluminium Nitrate

Our >99.999% (5N) purity aluminium nitrate is the purest product available at commercial scale. Key applications in particle coating, LED, aluminate scintillators and other speciality products.



Ultra Aluminium Sulfate

Our >99.999% (5N) aluminium sulfate is the purest product available at commercial scale. A premium product for synthesis of aluminium cathode active materials (CAM) with NCA, NCMA and NFA.

Our products for the lithium-ion cell

CATHODE

Cathode pre-cursors for
NCA & NCMA and
alumina coating

5N Al-Nitrate
+
5N Al-Sulfate

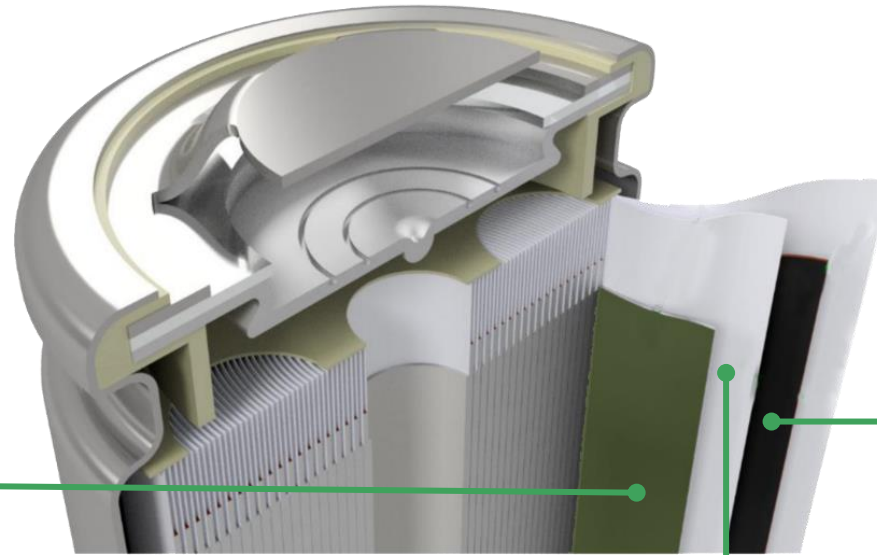

ANODE

Pre-cursors for coating
graphite and silicon
anode

5N Al-Nitrate

SEPARATOR

Ceramic coating for
thermal management

HPA
&
**High Purity
Boehmite**



Lithium-ion battery separator coating

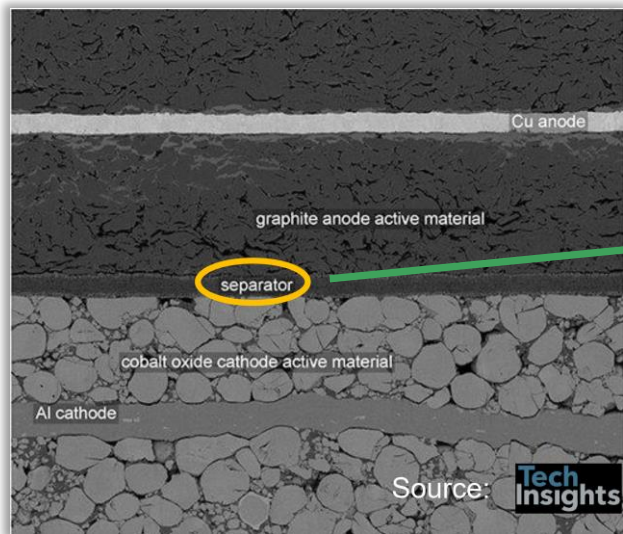
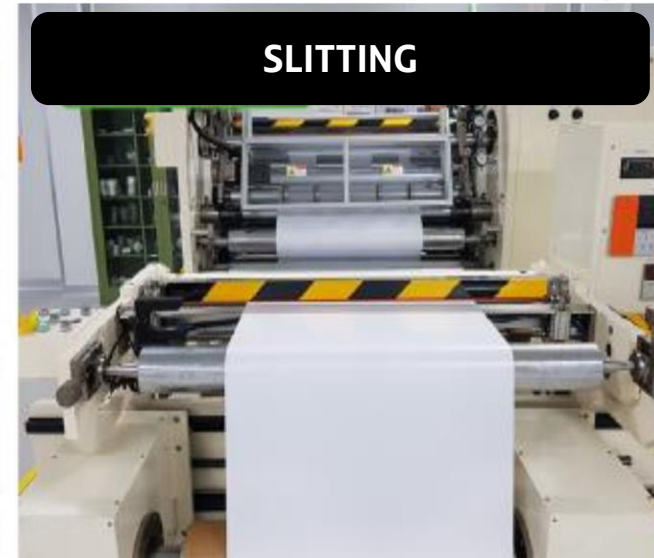
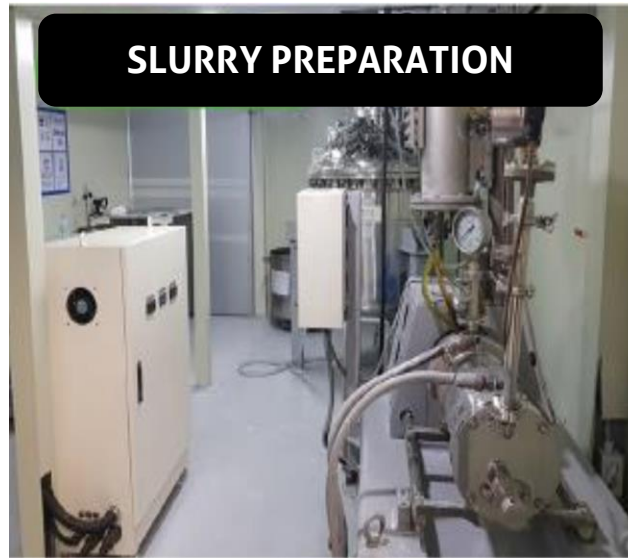

HPA Coated Separator

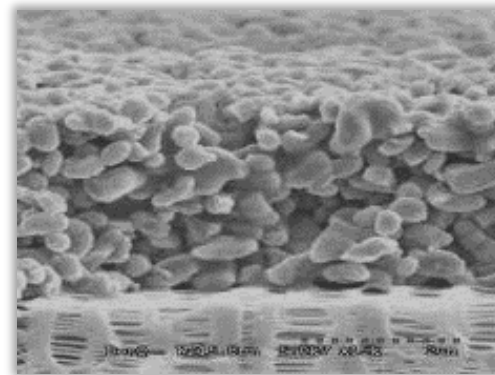

Boehmite Coated Separator

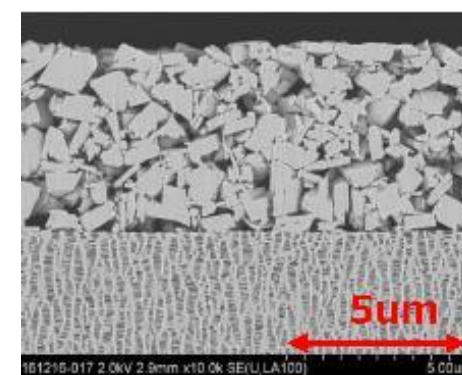

5N Aluminium Precursors: For Li-B Cathodes & Anodes:

- For synthesis of aluminium-bearing, lithium-ion battery cathode active materials (CAM)
- Used in aluminium bearing cathode chemistries, ie:
- NCA (eg: Tesla)
- NCMA (eg: GM-Ultium)
- NCA + NCMA chemistries forecast ~80% of all Li-B cathode by 2030 (UBS)
- High Ni (>80%) cathode increasingly require Al_2O_3 coating using Al-Nitrates
- **Alpha HPA's precursors considered the highest purity globally**

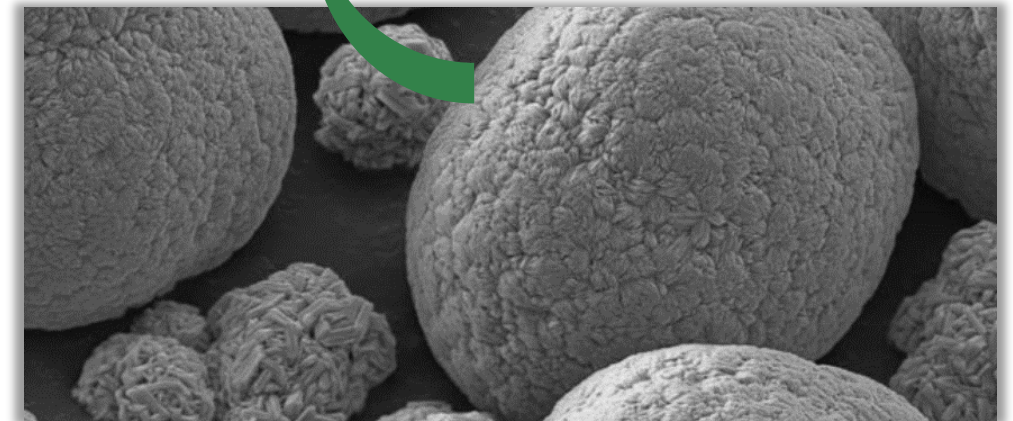
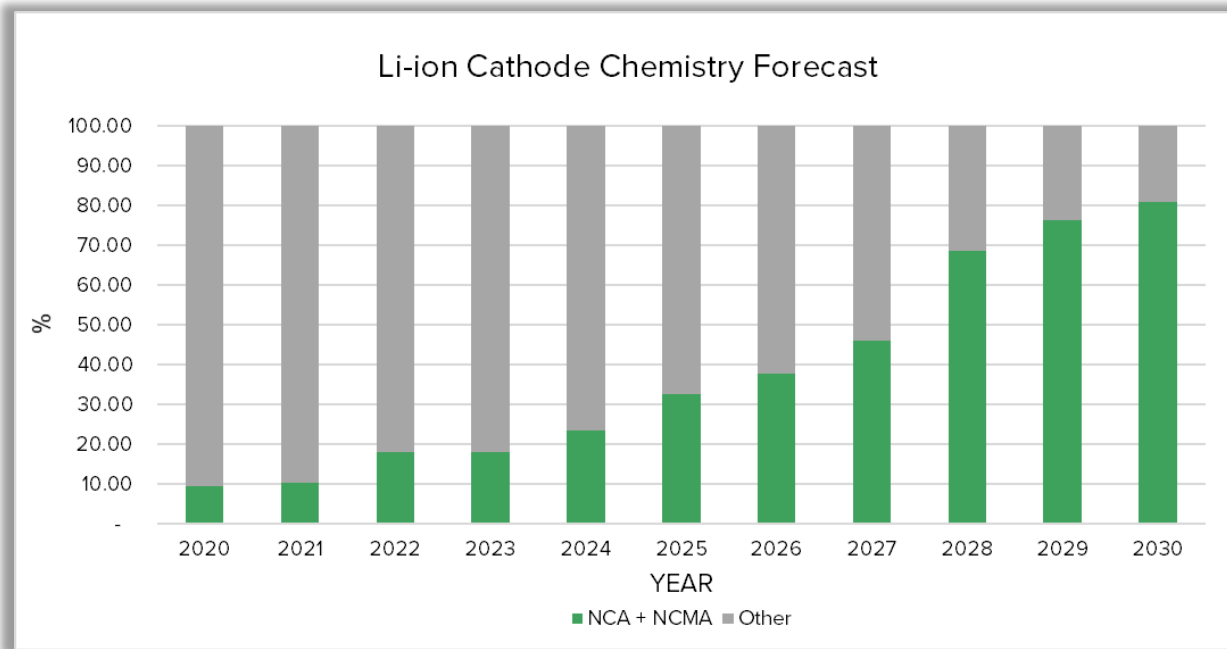
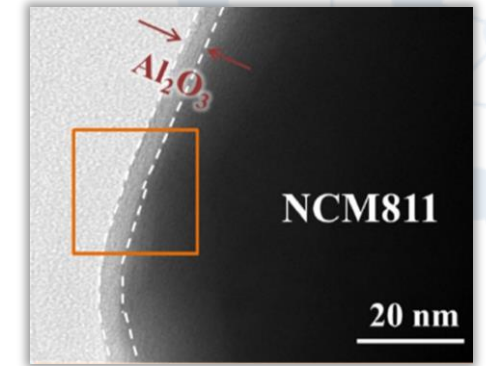

SEM of NCA Cathode Active Materials (CAM)

NCA + NCMA Cathode Chemistries ~80% by 2030

Source: UBS – Dec 2020

Our products for LED lights

LED PHOSPHORS

Synthesis of Aluminate (YAG) Phosphors for white LEDs

HPA
+
5N Al-Nitrate

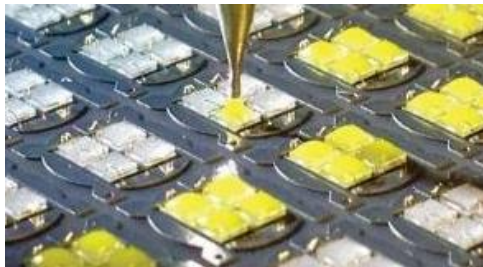

Addition of YAG phosphors to LED lighting circuits

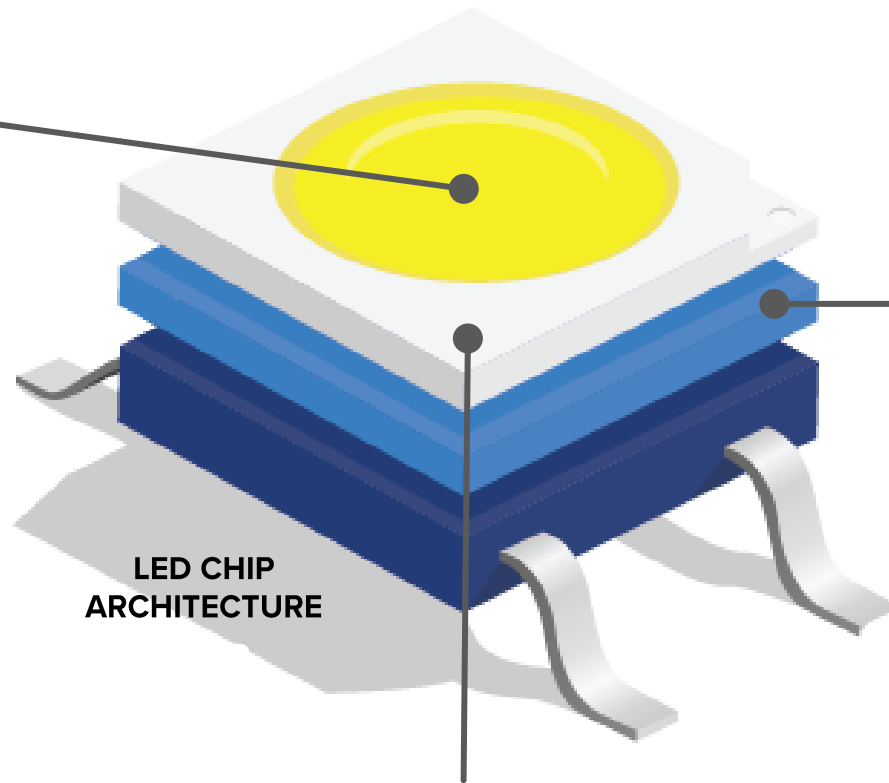

Ga-N circuit & Active Layers

SAPPHIRE GLASS WAFERS

Sapphire crystal growth cut to sapphire wafer

HPA Pellets

5N Aluminium-Nitrate: Micro-LED's

- Adoption of micro-LED's has the potential to double existing LED market
- Micro LEDs's require nano-size phosphors
- Nano-size phosphors increasingly require 'wet process' synthesis >> using Al-nitrate

MicroLED Market

MicroLEDs set to double the size of the entire LED market: +17 Billion USD by 2025*

Source: MarketWatch, Inc.

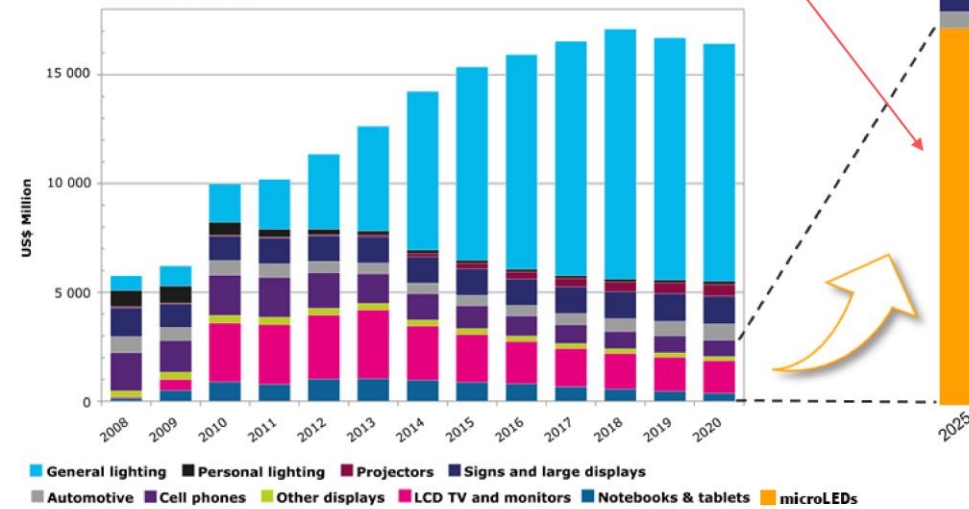

Apple LuxVue (Acquired)
Facebook mLED, InfiLED, Plessey (Acquired)
Intel Aledia (Equity Invest.)
Google g1o (Equity Invest.)

Sapphire Glass Manufacture:

ALOX Technology

- Alpha HPA is qualified for single crystal sapphire boule production grown by premium sapphire glass manufacturer ALOX Technology
- Alpha HPA now in discussions with ALOX on commercial supply



Alpha HPA's sintered pellets



Crucible stacking



Single crystal boule

Near term production: Precursor Production Facility (PPF)

- **Fully funded PPF construction underway** to fast-track production of 5N Al-precursors at ~200 tpa
- Also delivering bespoke volumes of HPA and boehmite (1-5 tonnes per annum)
- To be constructed within Alpha's existing HPA First Project site at Gladstone
- Fully vendor quoted CapEx ~A\$27.6M
- Targeting August 2022 Production

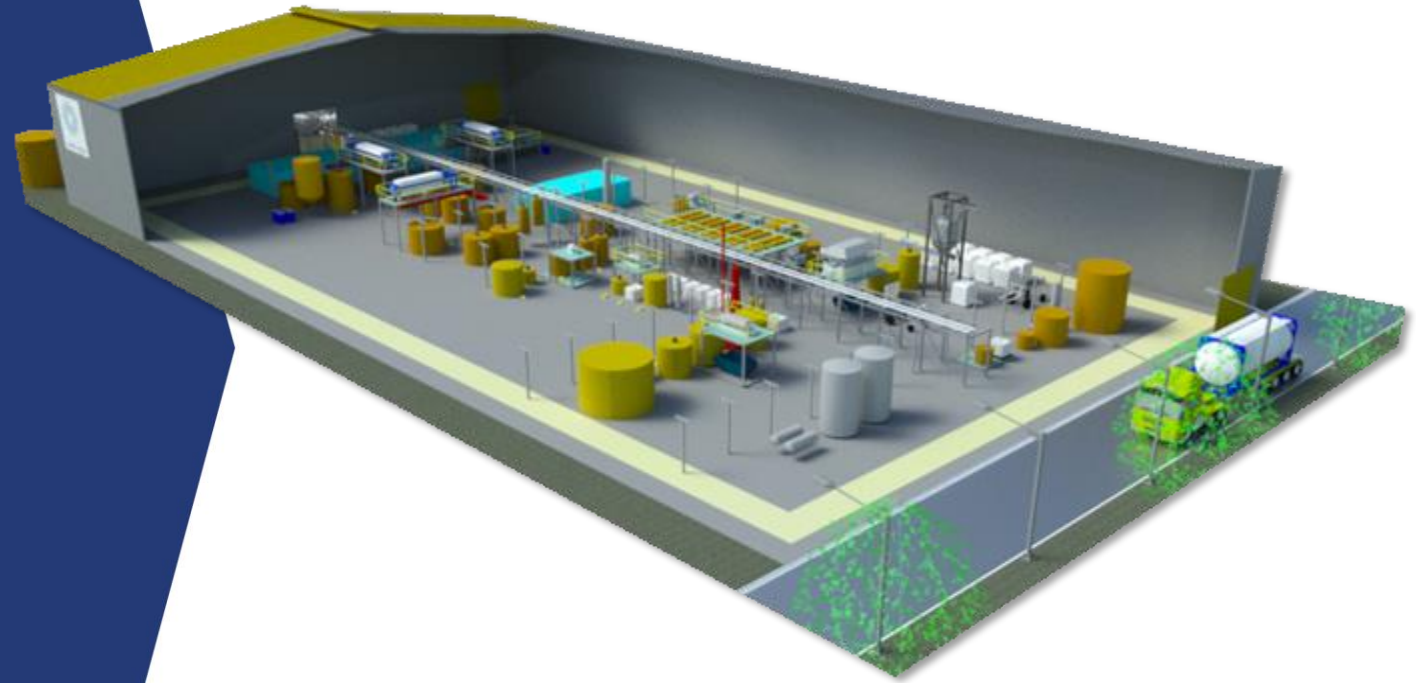

3D Schematic
HPA First Project
Precursor Production Facility

Stage 1: Precursor Production Facility (PPF)



PPF: September 2022



Project Layout: PPF and Full Scale Facility

- The PPF to be constructed within the HPA First Project Footprint
- To be incorporated into the Full Scale HPA First Plant as a dedicated unit for 5N Al-Sulfate.
- alphahpa.com.au/our-projects

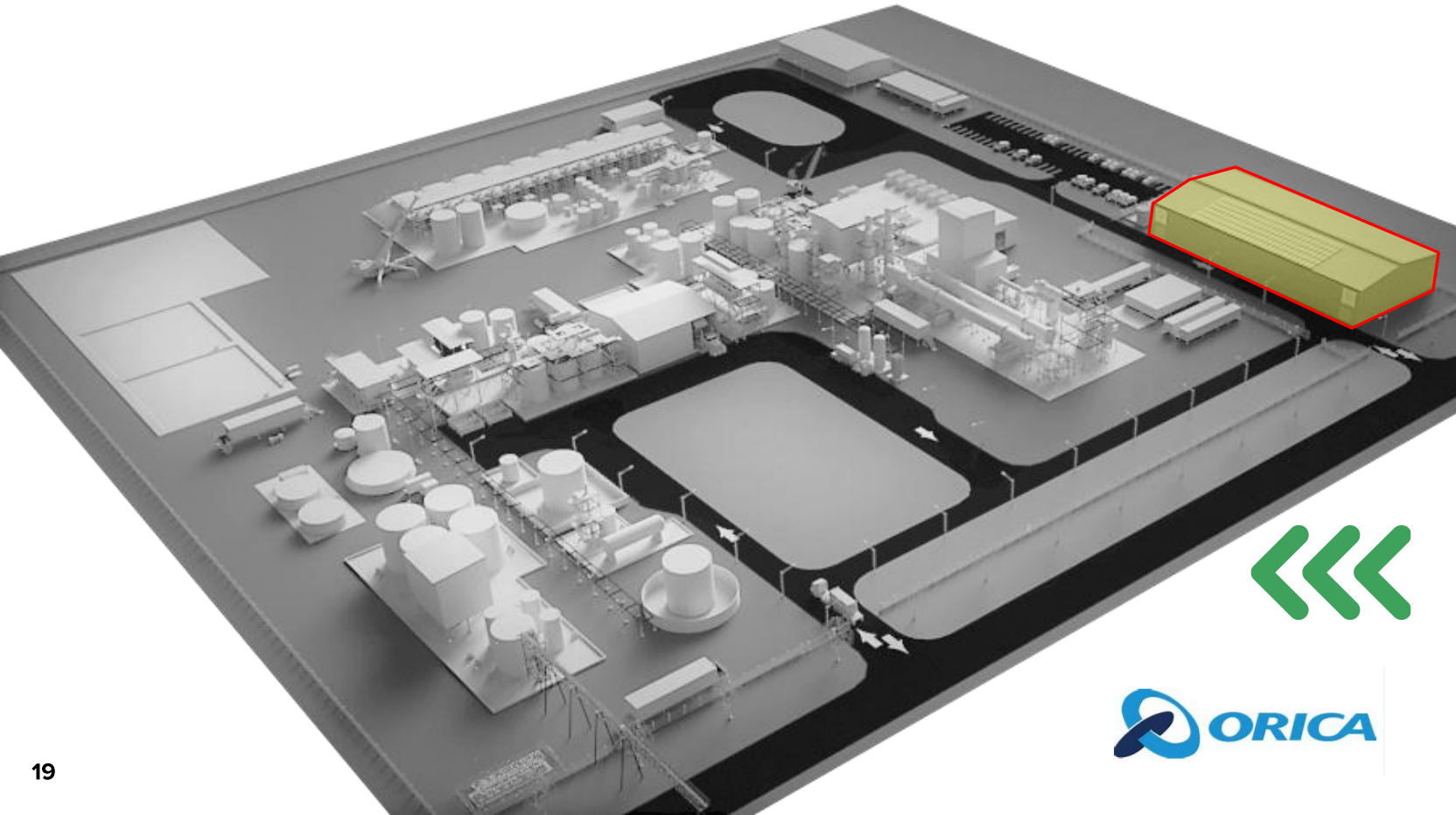

PPF to be constructed within the HPA First Project footprint, and then incorporated into the full-scale commercial plant.



Orica to supply reagents and offtake by-product for both the PPF and the full-scale facility



HPA First Project: Brisbane Plant >>>

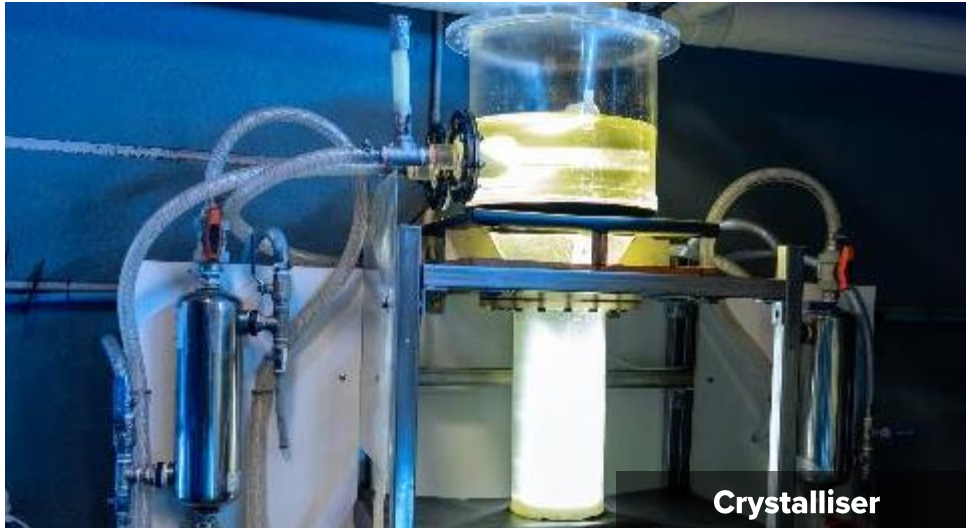

Crystalliser



Pre-Cursor Room



Pelleting Room



Solvent Extraction

- Continuously operating facility, with over 3,500 operating hours
- Aluminium nitrate production to date >5,100kg
- Servicing specialty sales and continued product test orders

HPA First Project: Global Product Marketing

- Global Marketing Network established
- >80 product samples now distributed globally to >40 end users
- Products qualified for sapphire glass, LED phosphors and separator coatings
- Al-nitrate and HPA sales commenced
- **Sept 2021:** Multiple (8) bids submitted for high value supply contracts

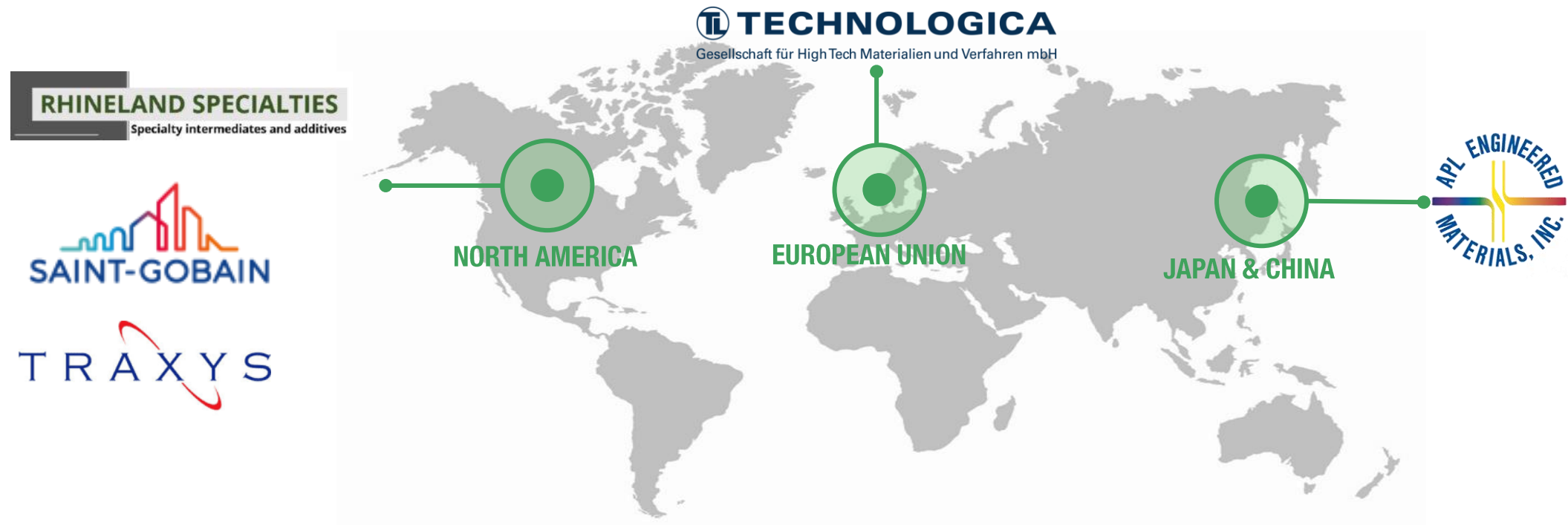

Product Marketing: Understanding our Customers

- Detailed technical interaction allows us to deliver to our customers requirements

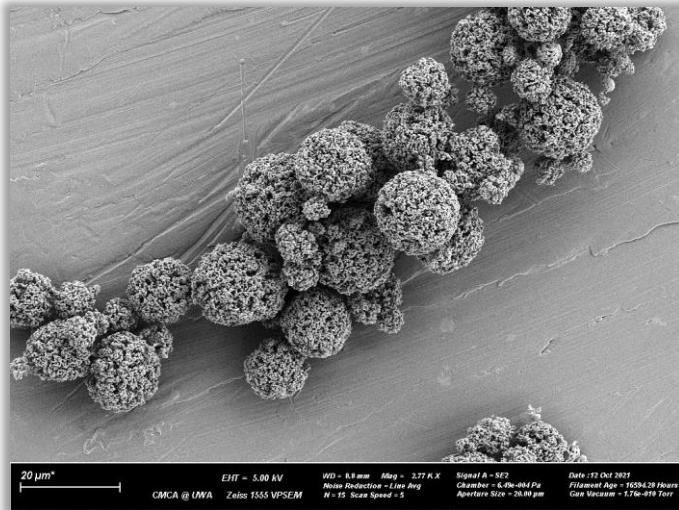

HPA spheres for Japanese electronics OEM

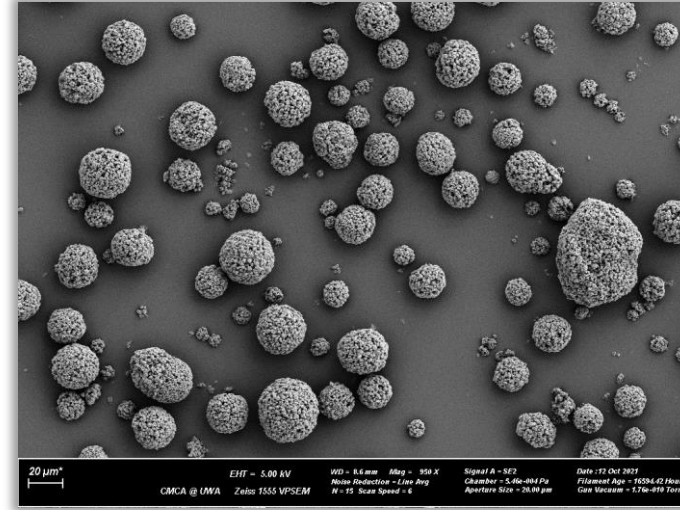

Dispersible boehmites for US ceramics OEM

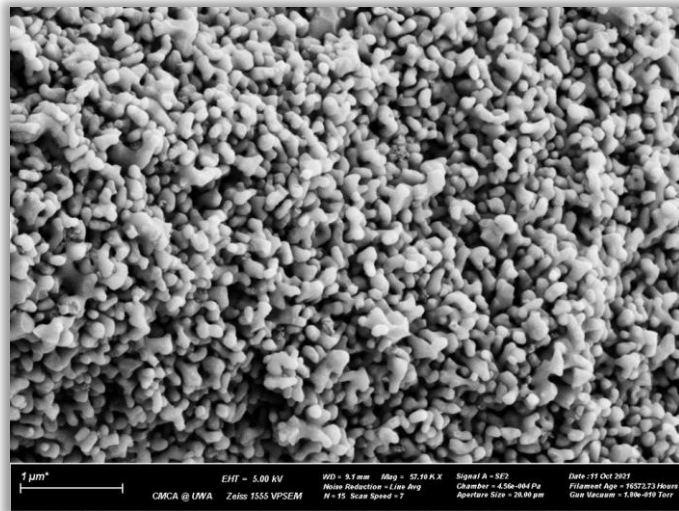

Sub micron HPA for German based LED phosphor OEM



HPA coated Li-B anodes for EU anode OEM

AlphaHPA

HPA First Project: Low Carbon Footprint

- Alpha HPA has a MOU with CleanCo (QLD) for up to 100% renewable energy supply
- 100% renewable energy supply represents a 59% reduction in Co2 emissions vs the incumbent (alkoxide) HPA process

Item	Tonnes CO ₂ per tonne HPA	CO ₂ Reduction
Incumbent alkoxide process	12.44	
HPA First Project - process baseline	9.5	22.4%
HPA First Project - 50% renewable electricity purchase	7.3	41%
HPA First Project - 100% renewable electricity purchase	5.04	59%

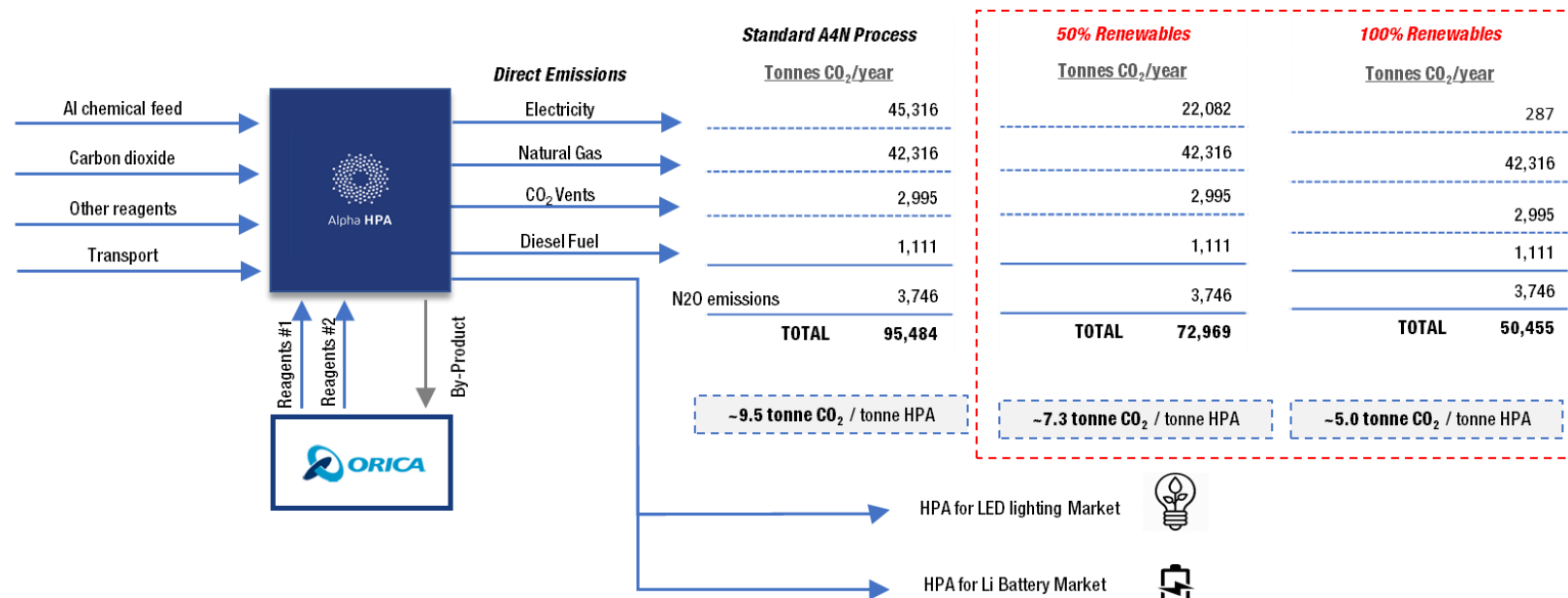

**Incumbent HPA production process (bauxite>refinery>smelter>alkoxide>HPA) estimated to have a 776J per tonne HPA energy profile = 12.3 tonnes CO₂ per tonne HPA

HPA First Project: DFS (March 2020)

- Comprehensive technical and financial validation of the Company's HPA First Project
 - Production rate of 10,000tpa HPA
 - Annual free cashflow increased to A\$280M**
 - Strong Project cashflows under all modelled price scenarios (US\$15/20/25kg HPA)
 - Unit cash costs of A\$8,730 (**US\$5,940/t or US\$5.94/kg**) HPA after by-product credits
 - Project CapEx of A\$308M (**US\$209M**)
 - Capital intensity of A\$30,800 (US\$20,900)/tpa HPA
 - Financially robust project with high profitability at HPA prices as low as US\$10,000/t

Key Project Parameters	HPA Pricing Scenarios					
	USD \$25/kg		USD \$20/kg		USD \$15/kg	
	AUD	USD	AUD	USD	AUD	USD
Annual Revenue @ 10,000tpa	\$368 million	\$250 million	\$294 million	\$200 million	\$221 million	\$150 million
Annual Pre-Tax Cashflow	\$280 million	\$191 million	\$207 million	\$141 million	\$133 million	\$91 million
Payback	< 2 years		<3 years		<4 years	

*HPA price of US\$25/kg and USD/AUD = 0.68

**Relative to March 2019 PFS = A\$265M

HPA First Project: Status and Catalysts

DFS

TRAXYS



SAINT-GOBAIN



ORICA

NAIF
Northern Australia Infrastructure Facility



Mar '20 Definitive Feasibility Study – ROBUST PROJECT CONFIRMED

Aug '20: Offtake, marketing & financing MOU with Traxys

Sept '20: 2 x High-purity Li-B Pre-Cursor manufacture confirmed

Feb '21: Major Project Permitting Approval (MCU)

Feb '21: HPA Pellets qualifies for sapphire glass manufacture

Apr '21: MOU with Saint Gobain – all products

May '21: HPA powder qualifies for LED phosphor manufacture

May '21: MOU with CleanCo QLD to provide up to 100% Renewable Energy

May '21: Lenders Engineers (ITE) appointed – Final bank technical DD

Aug '21: Orica Definitive Agreements

Sep '21: NAIF – Strategic Assessment Phase Approval

Nov '21: Project Site Secured

Current: Global Outreach >80 end-user test products shipped, multiple products under Devt.

Pending: Large Volume Product Offtakes

Pending: Final Product Mix and DFS Update

Pending: Project Financing and FID

Aug '22: COMMERCIAL PRODUCTION OF 5N AI-PRECURSORS - PPF



Corporate Snapshot

TRADING INFORMATION

ASX CODE	A4N
Share Price (08/11/2021)	~49c
52-week trading range	14c – 67.5c
Issued Shares	793.3M

CAPITAL STRUCTURE

Issued Shares	793.3M
Unlisted options (@20c)*	10.0M (expire 31 July 2022)
Unlisted options (@30c)	34.0M (expire 31 July 2022)
Unlisted options (@35c)*	5.0M (expire 30 Sept 2023)
Unlisted options (@35c)	26.0M (expire 31 July 2023)

Market Cap	\$389M
Est Cash (30-09-2021)	~\$46M – No Debt
Enterprise Value	\$343M

* Licensor Options

SHARE PRICE PERFORMANCE – 12 MONTHS

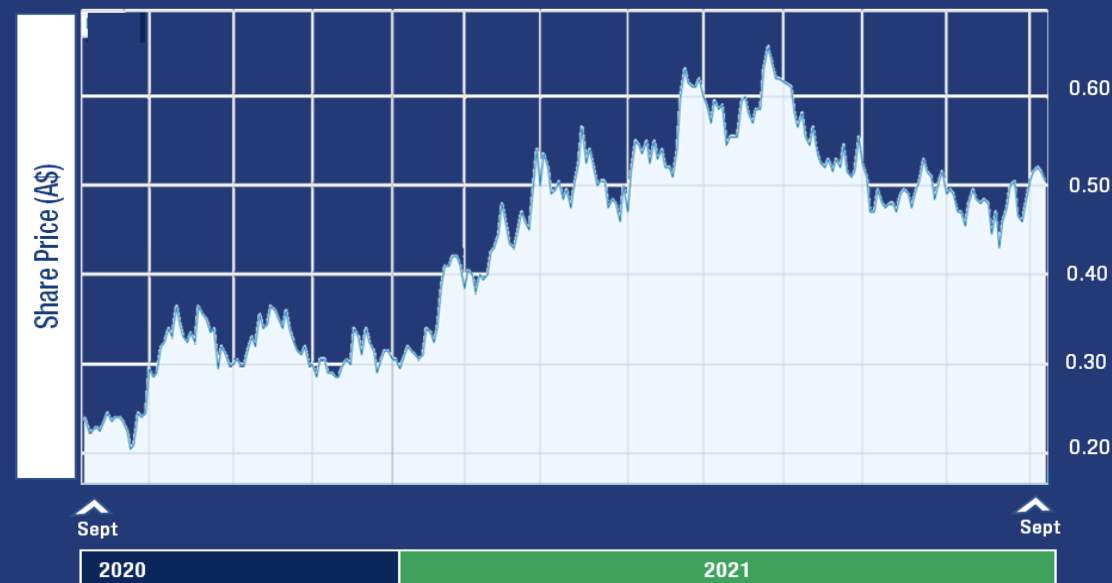

SHAREHOLDERS

TOP 20

Regal Funds	7.46%
Permgold P/L (N. Seckold)	8.5%

55%



THANK YOU

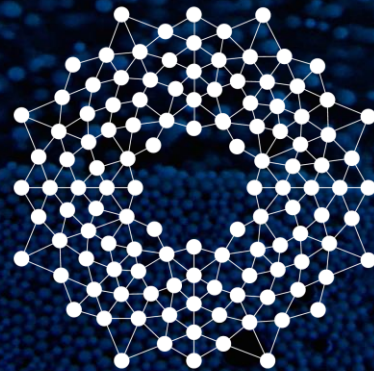

Alpha HPA

Contact

Rimas Kairaitis
Managing Director

rkairaitis@alphahpa.com.au

+61 408 414 474

Cameron Peacock
Investor Relations and Business Development

cpeacock@alphahpa.com.au

+61 439 908 732

alphahpa.com.au

